

**DIMENSIONS IN MM (INCHES)**

Wall mounting enclosure with blind or PVC window, front door hinged, with/without deadfront. The full-welded body is supplied with a galvanized mounting panel, 2 mm (14ga) thick.

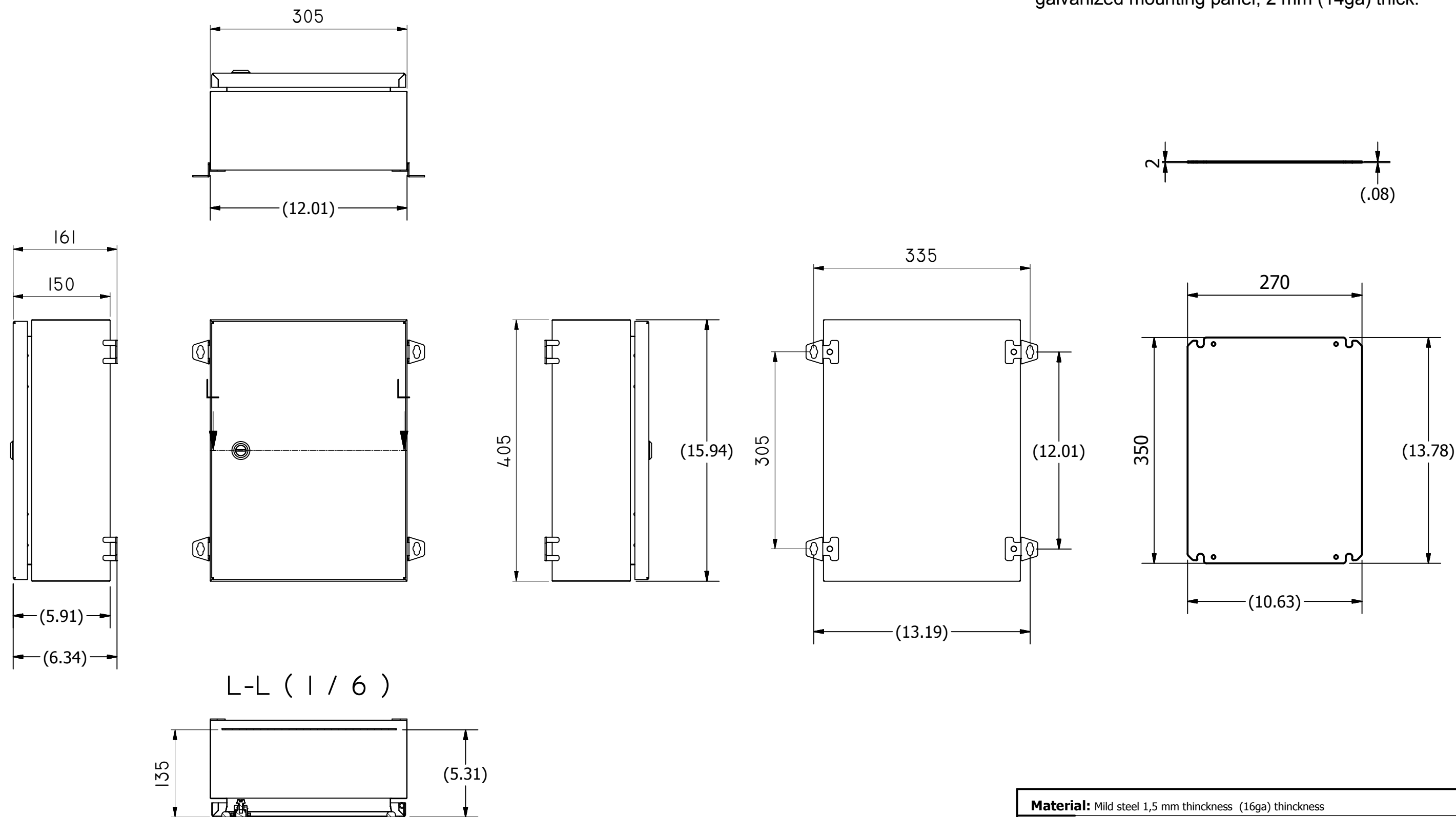

<b>Material:</b> Mild steel 1,5 mm thickness (16ga) thickness	
<b>Painting:</b> Powder coating	
28060	Scala 1/6
<b>Standar Colors:</b> RAL 7035 textured	
<b>Protection category and Approvals:</b> IP66 EN 60 529 - IK10 EN 62 262	
UL/CuL TYPE,1,12,4	