

DIMENSIONS IN MM (INCHES)

Wall mounting enclosure with blind or PVC window, front door hinged, with/without deadfront. The full-welded body is supplied with a galvanized mounting panel, 2 mm (14ga) thick.

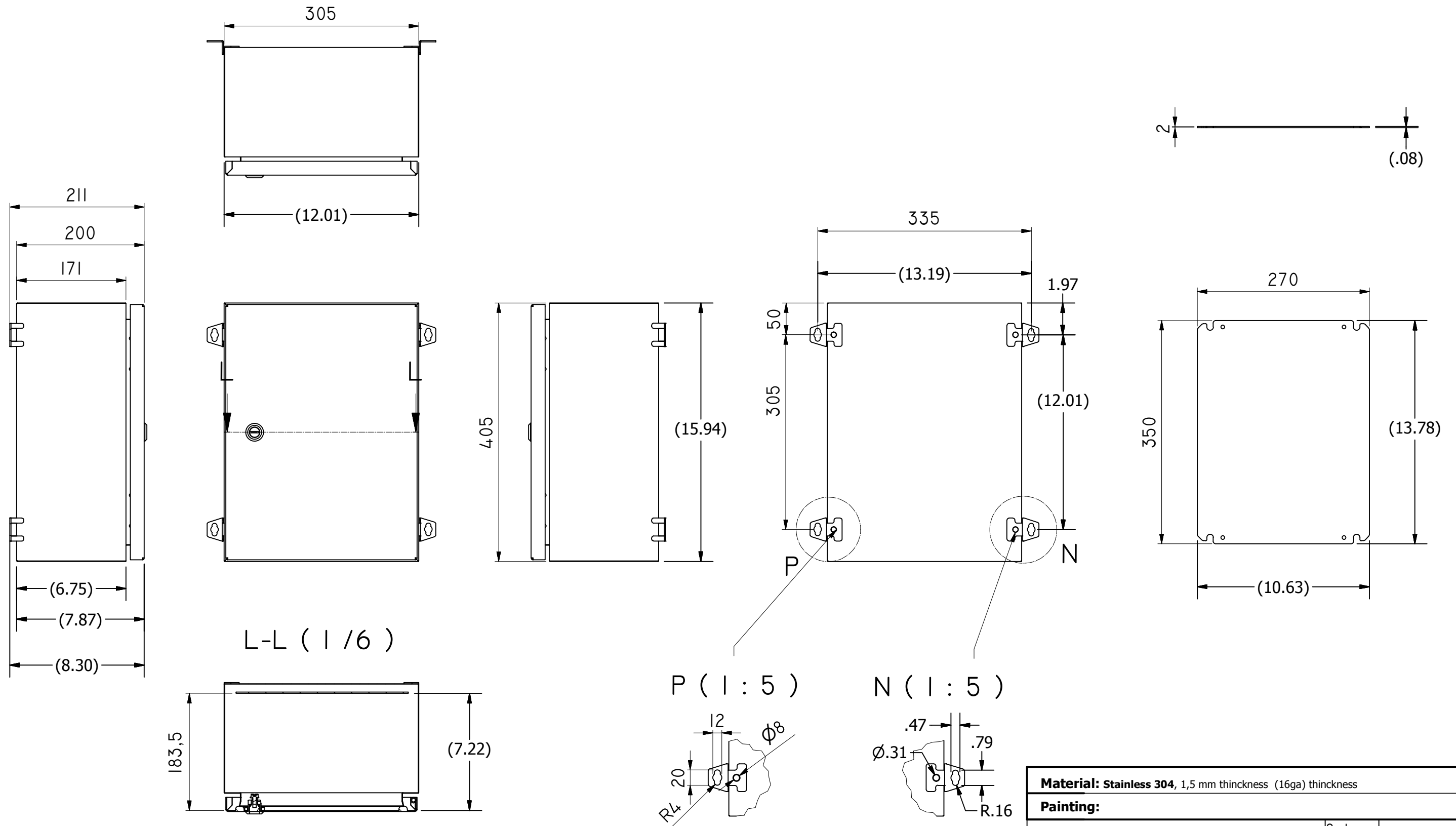

L-L (1 / 6)

P (1 : 5)

N (1 : 5)

Material: Stainless 304, 1,5 mm thickness (16ga) thickness		
Painting:		
28070ss	Scala 1/6	
Finish: Fine scotch brite medium satin, 240 grit.		
Protection category and Approvals: IP66 EN 60 529 - IK10 EN 62 262		UL/CuL TYPE,4x