

**DIMENSIONS IN MM (INCHES)**

Wall mounting enclosure with blind or PVC window, front door hinged, with/without deadfront. The full-welded body is supplied with a galvanized mounting panel, 2 mm (14ga) thick.

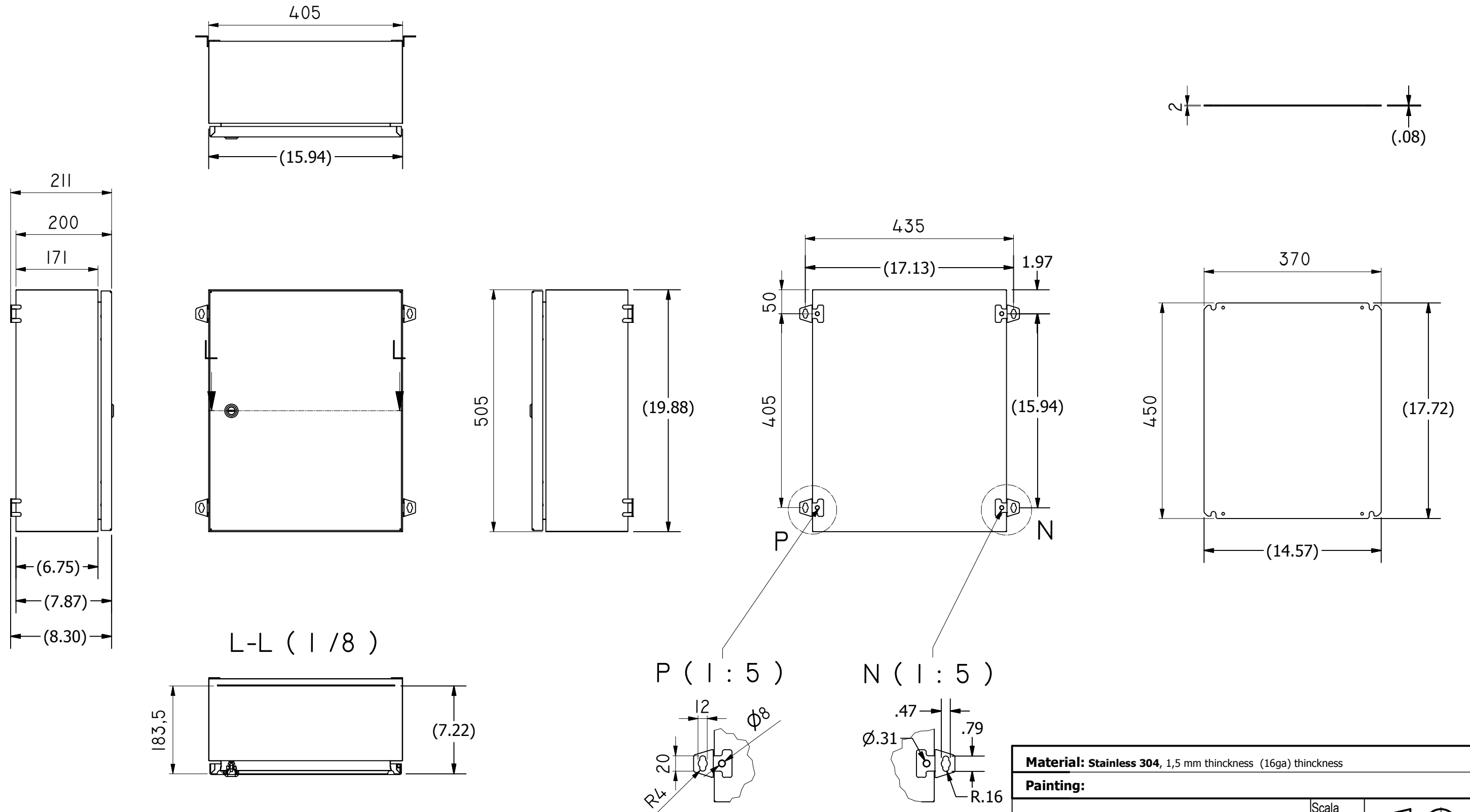

<b>Material:</b> Stainless 304, 1,5 mm thickness (16ga) thickness		
<b>Painting:</b>		
28116ss	Scala 1/8	
<b>Finish:</b> Fine scotch brite medium satin, 240 grit.		
<b>Protection category and Approvals:</b> IP66 EN 60 529 - IK10 EN 62 262		UL/CuL TYPE,4x