

DIMENSIONS IN MM (INCHES)

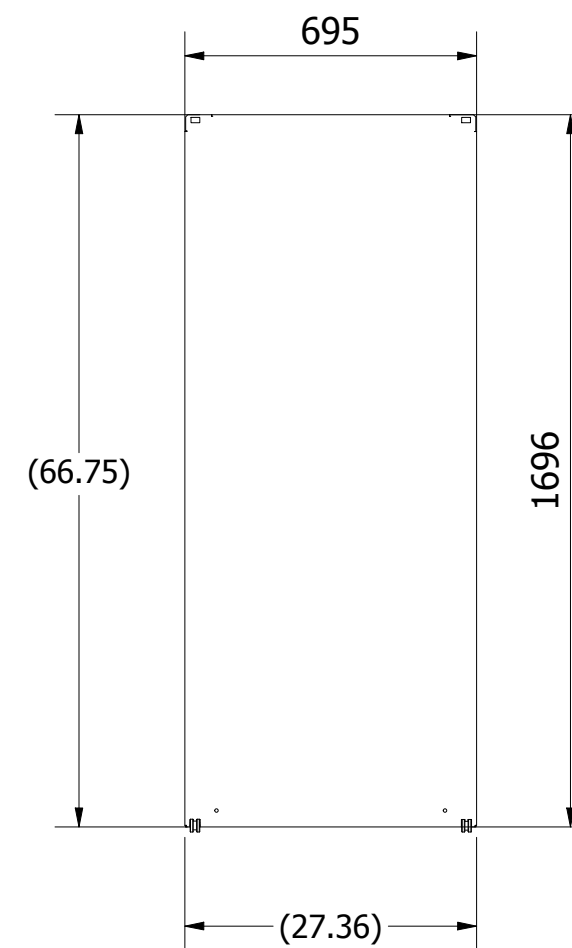

H-H ( 1 / 18 )

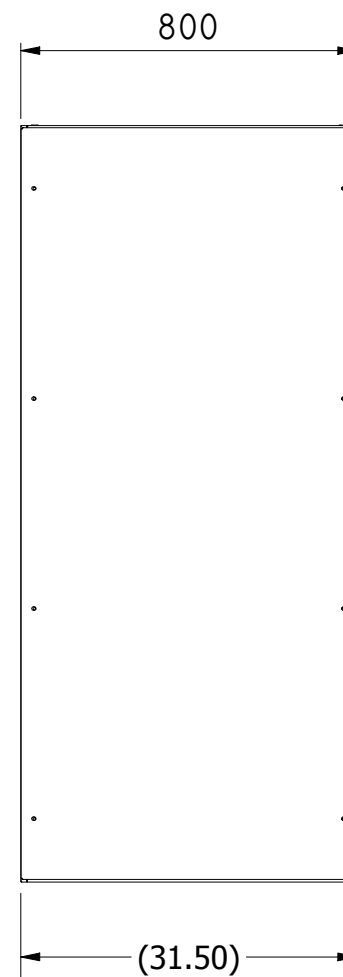
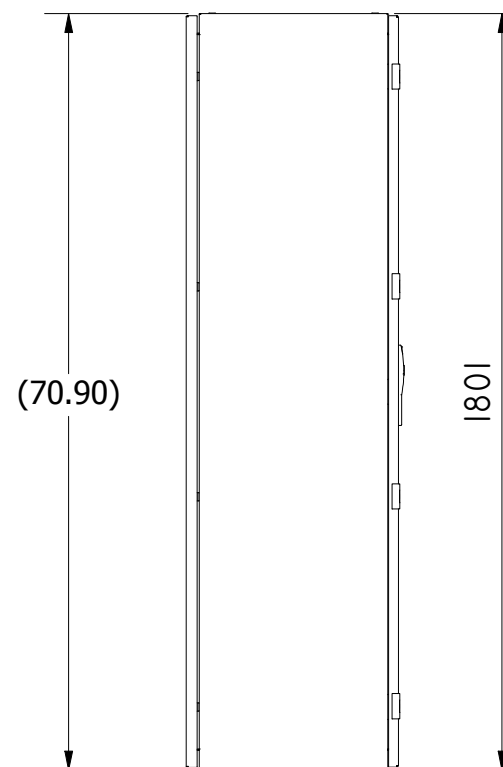
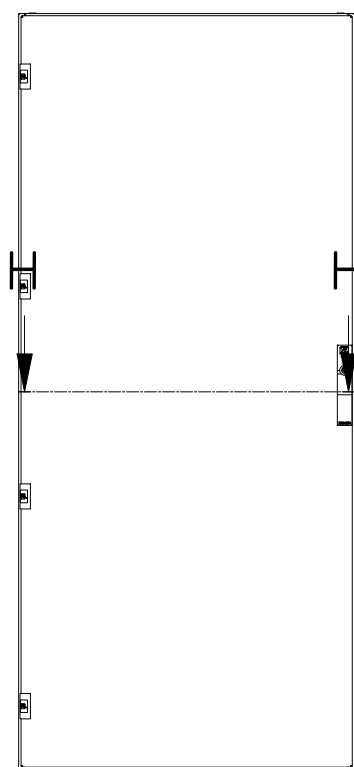
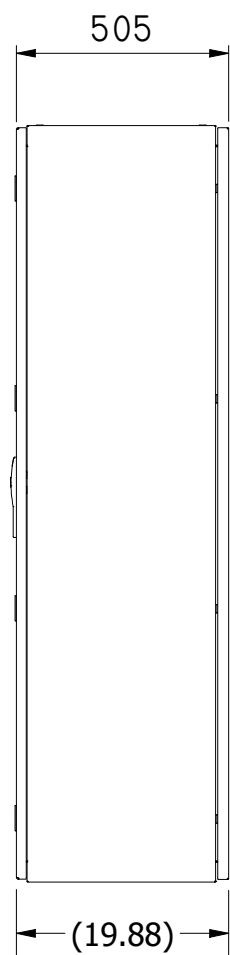
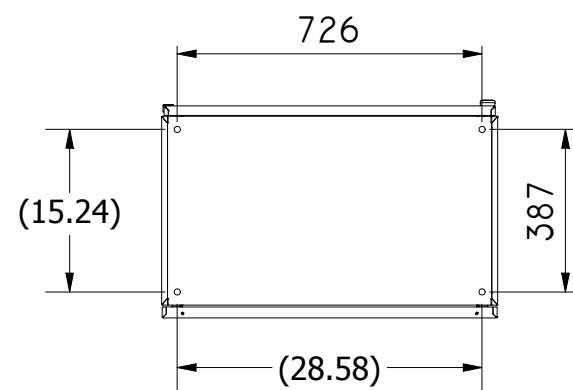
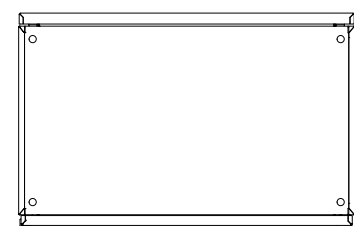
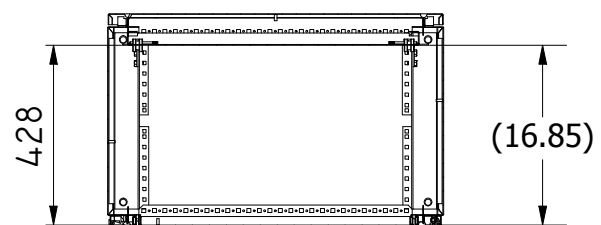

<b>Material:</b> Mild steel 1,5 mm thickness	
<b>Painting:</b> Powder coating	
TFR29	Scala 1/18
<b>Standard Colors:</b> RAL7035 textured	
<b>Protection category and Approvals:</b> IP66 EN 60 529 - IK10 EN 62 262	
UL/CUL type,1,12,4	