

DIMENSIONS IN MM (INCHES)

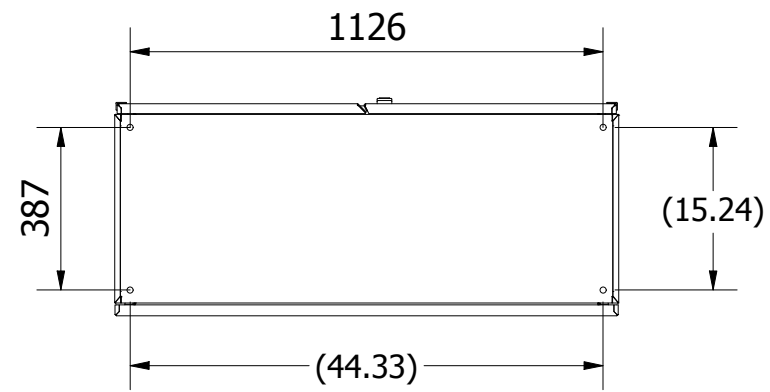

F-F (1 : 18)

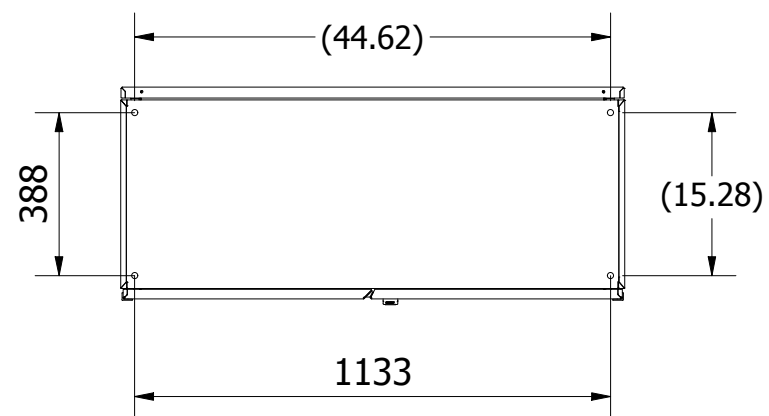
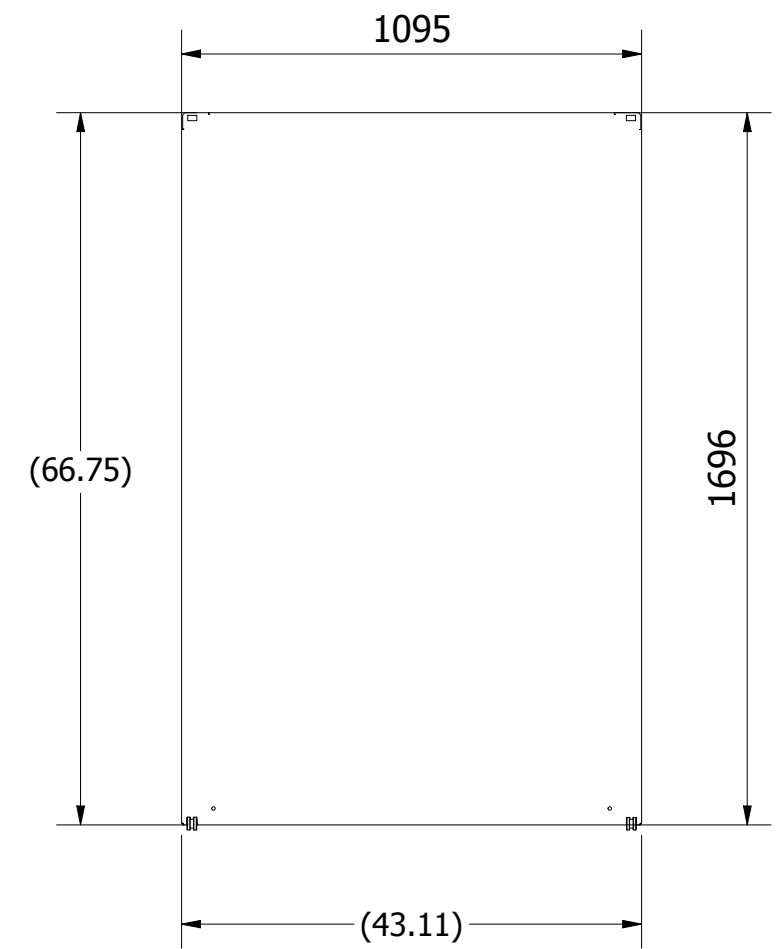
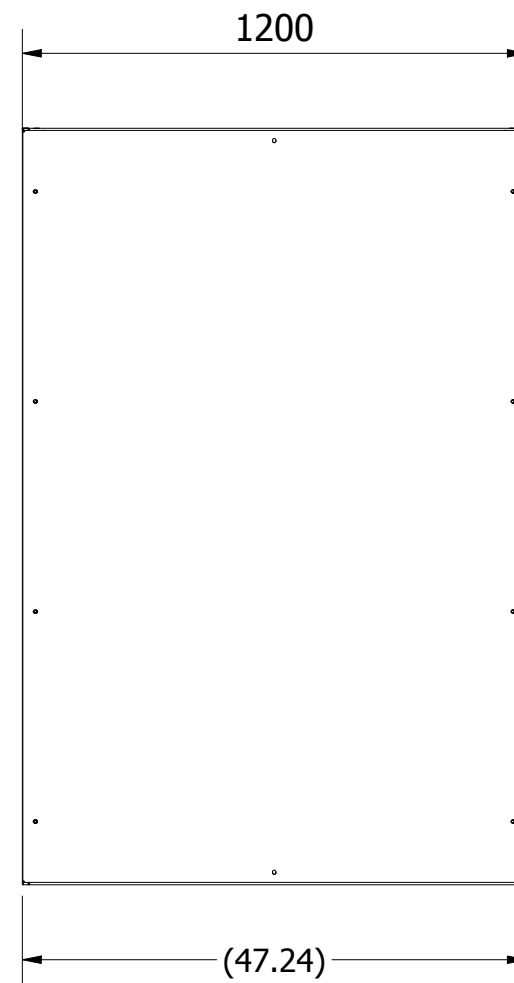
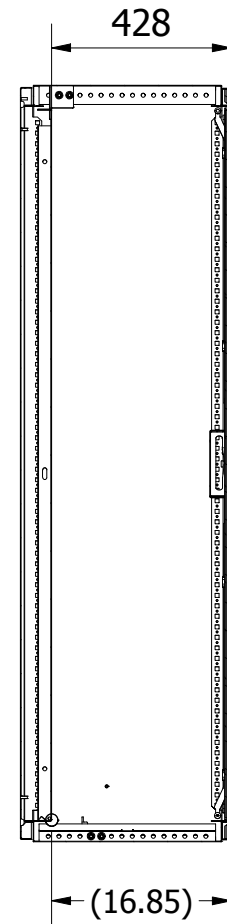
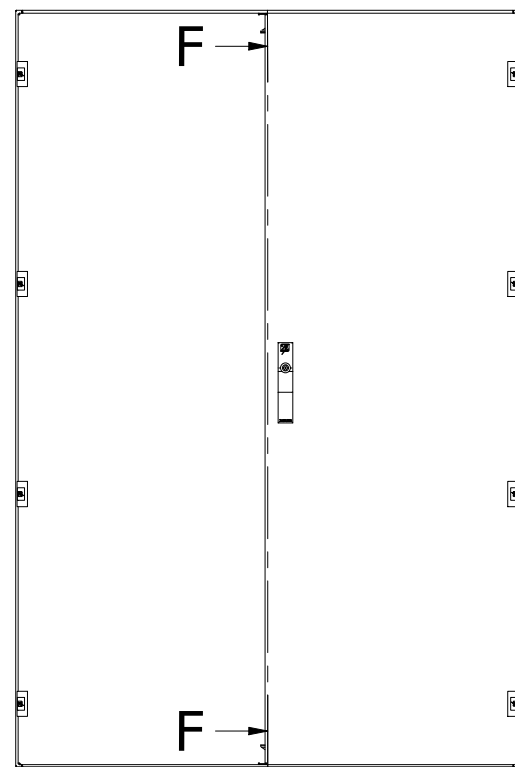
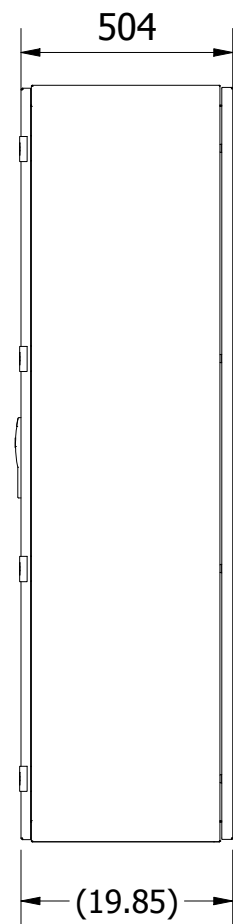

Material: Mild steel 1,5 mm thickness	
Painting: Powder coating	
TFR32	Scala 1/18
Standard Colors: RAL7035 textured	
Protection category and Approvals: IP66 EN 60 529 - IK10 EN 62 262	
UL/CUL type,1,12,4	